

Rumpf: gewickeltes Rohr
 vorn auf 6mm Dorn, hinten: auf Angelrute
 Abspannung: 0.1mm
 reißfester Bindfaden

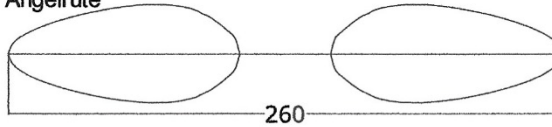

Prop: 36°@0.7r
 D: 260mm
 H: 412mm
 H/D=1.6

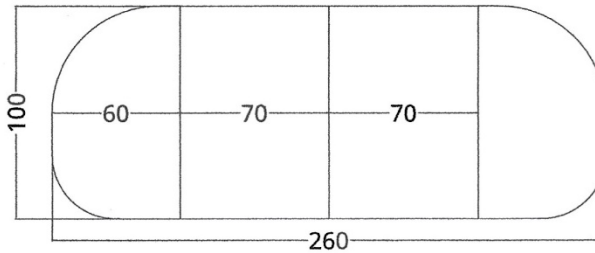
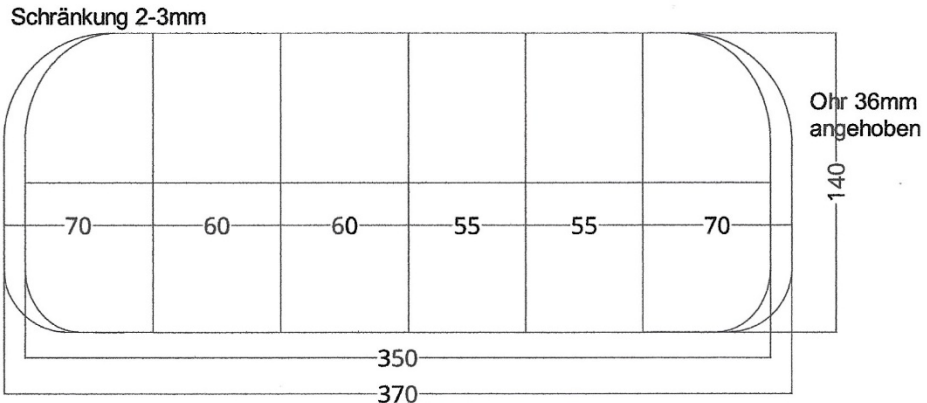
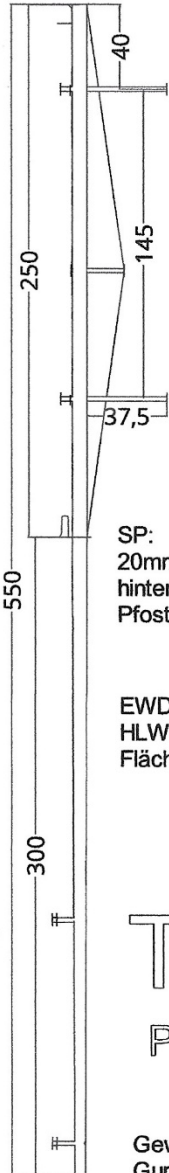

Gewichte [mg]:
 HLW: 173
 SLW: 47
 Fläche: 416
 Rumpf hinten: 329
 Rumpf vorn: 574
 Prop mit Hub: 519
 Gesamt: 2058

SP:
 20mm vor
 hinterem
 Pfosten

EWD:
 HLW: 0°
 Fläche: 2.7° / 6.5mm

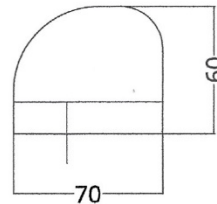
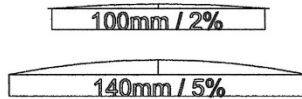

TH35 V2/2023

Paul Willutzki

Gewicht Modell: 2.06g
 Gummi (Limit 1g):
 TAN SS 2021/2022
 Gewicht Gummi: ca. 1.45 g/m
 Länge Schleife: 32-34cm

Leistungen: 1.Platz Bay. Meisterschaft 2023 / Ingolstadt
 8:29 / 8:16 min

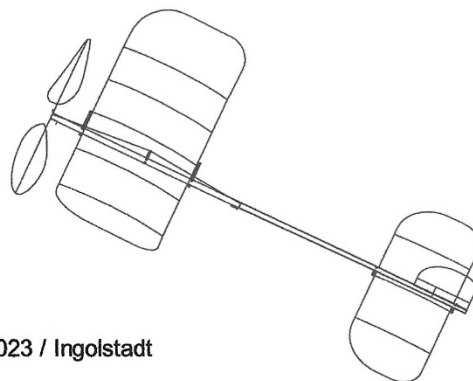

TH35 Saalflugmodell von Paul Willutzki